

TRACE™ Dual Monitor Mount

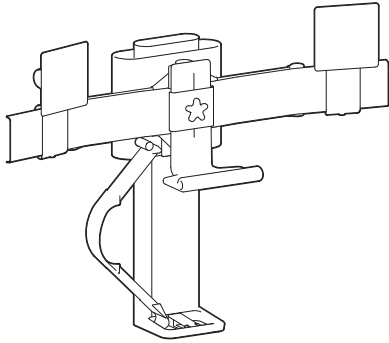

DIMENSIONS

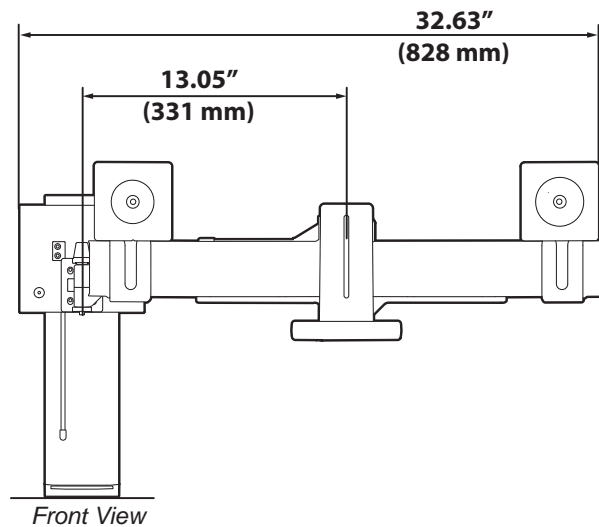
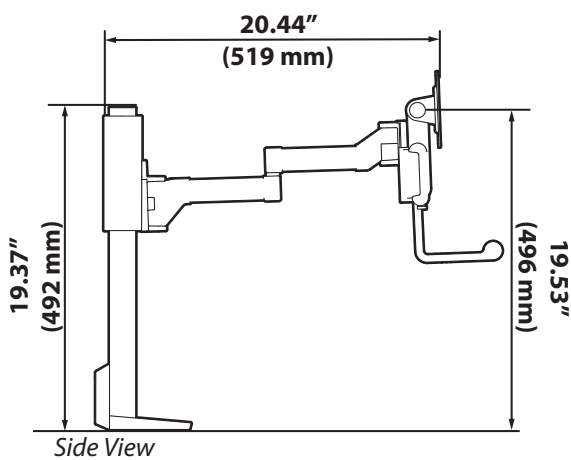
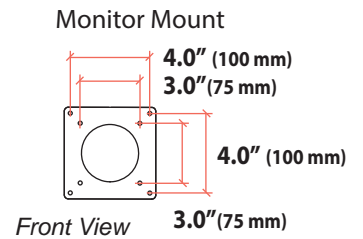
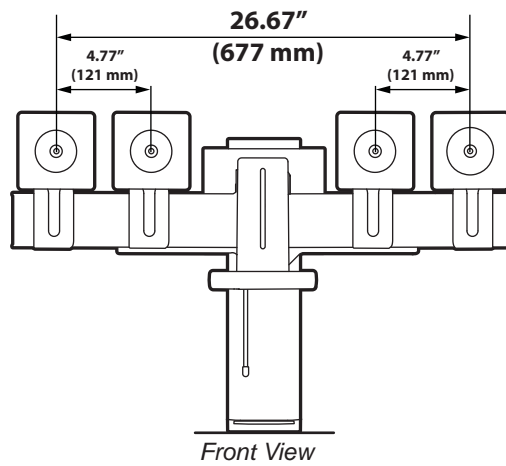
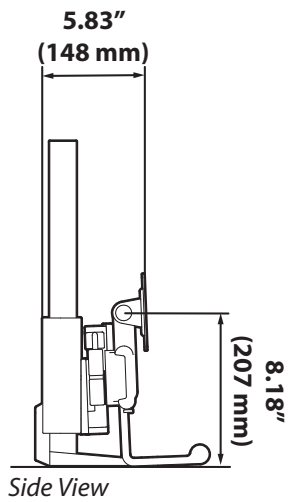

© 2020 Ergotron, Inc. rev. 09/02/2021 DIM-tracedual Content is subject to change without notification

**Americas Sales and
Corporate Headquarter**

St. Paul, MN USA
(800) 888-8458
+1-651-681-7600
www.ergotron.com
insidesales@ergotron.com

EMEA Sales

Amersfoort, The Netherlands
+31 33 45 45 600
www.ergotron.com
info.eu@ergotron.com

APAC Sales

Sydney, Australia
www.ergotron.com
apacustomerservice@ergotron.com

Worldwide OEM Sales

www.ergotron.com
info.oem@ergotron.com

TRACE™ Dual Monitor Mount

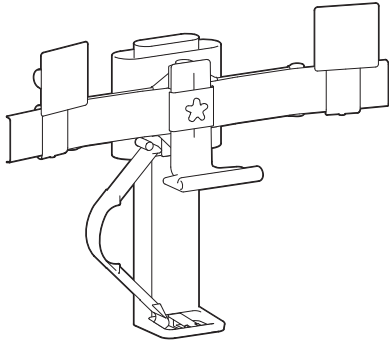

DIMENSIONS

Panel Clamp

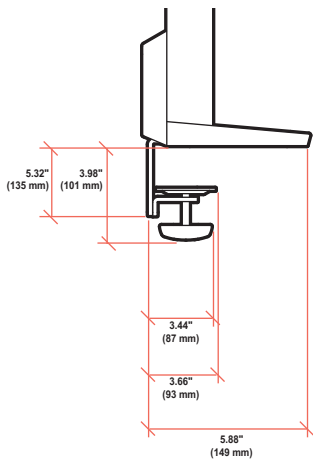
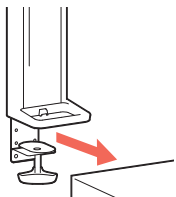

Desk Thickness

0" - 2.55" (0 - 65 mm)

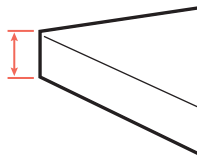

Freestanding Clamp

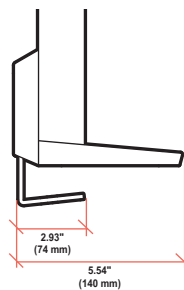
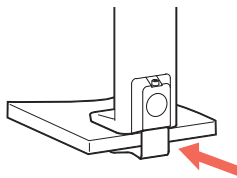

Desk Thickness

0.47" - 1.26" (12 - 32 mm)

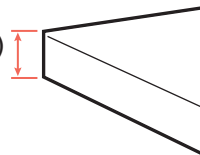

Grommet Mount

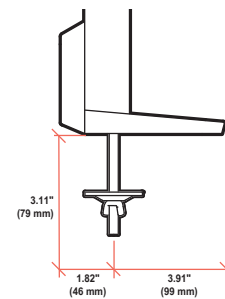
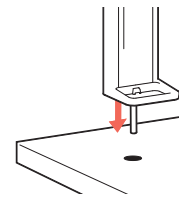

Desk Thickness and Grommet Hole

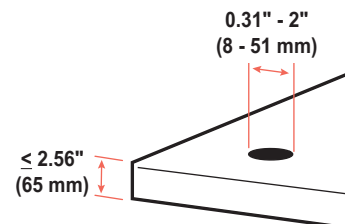

TRACE™ Dual Monitor Mount

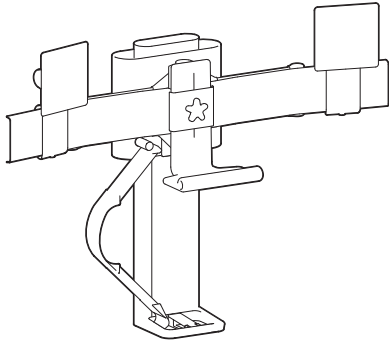

RANGE OF MOTION

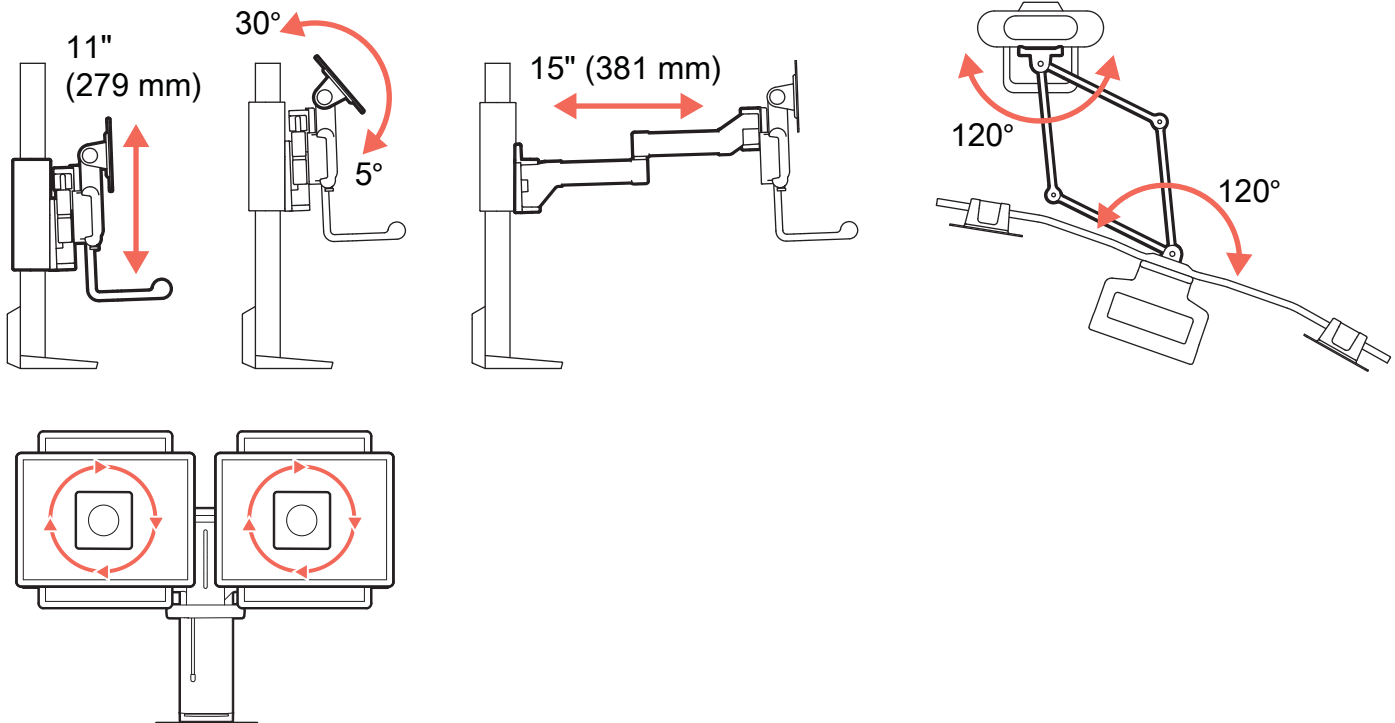

WEIGHT CAPACITY

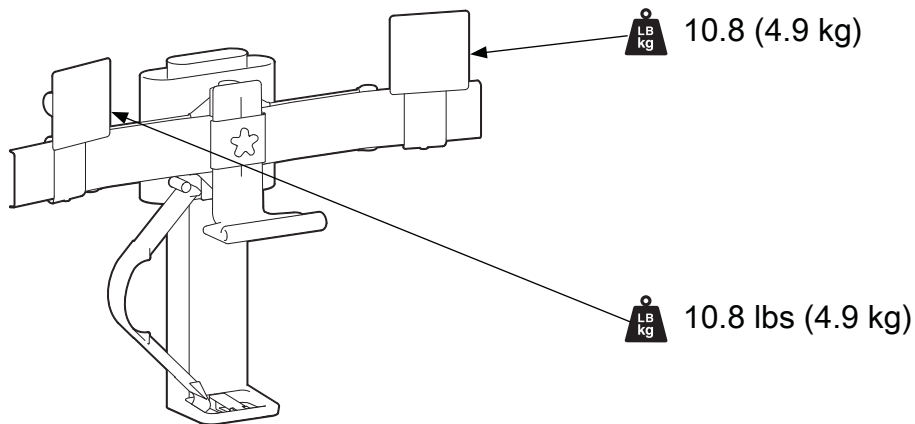

© 2020 Ergotron, Inc. rev. 09/02/2021 DIM-tracedual **Content is subject to change without notification**

Americas Sales and Corporate Headquarter	EMEA Sales	APAC Sales	Worldwide OEM Sales
St. Paul, MN USA (800) 888-8458 +1-651-681-7600 www.ergotron.com insidesales@ergotron.com	Amersfoort, The Netherlands +31 33 45 45 600 www.ergotron.com info.eu@ergotron.com	Sydney, Australia www.ergotron.com apaccustomerservice@ergotron.com	www.ergotron.com info.oem@ergotron.com