

ergotron®
moving you forward

GLOBAL
NOVEMBER 2021



Moving you forward

Research and customer feedback show that freedom to move while working leads to better health, greater productivity and a more positive attitude. At Ergotron, our mission has always focused on transforming static workplaces into dynamic environments that allow our customers to thrive. This means moving people forward by improving how they work, learn, play and care for others.

Whether in office, home, healthcare or educational settings, Ergotron is respected for industry-leading, professional-grade products. Our ergonomic movement solutions are designed for the rigors of a commercial audience, engineered for durability and tested to performance excellence. We are proud to hold more than 200 patents for unique product innovations and to have received countless accolades and awards.

Your input remains a crucial component in our product development process—and your loyalty tells us we're continuing to move you in the right direction.

Thank you for your continued trust in the Ergotron brand.



WORKFIT DESK CONVERTERS

Every body and every workspace is different. With the widest selection of styles, sizes and accessories, Ergotron's WorkFit family of sit-stand solutions helps employees find their best fit. The ability to easily go from sitting to standing and back again allows employees to choose how they work to reclaim the energy they need to feel and perform at their best.

WORKFIT™



Tabletop Desk Converters



The new standard: WorkFit-TX

Thoughtfully designed to offer advanced ergonomics out-of-the box, the WorkFit-TX fits more users with an X-shaped lift that folds close to your desk to keep the right monitor-to-keyboard-tray spacing. With a height-adjustable, back-tilt keyboard that sits below the worksurface, this ultra-low sit-stand workstation delivers leading ergonomics when sitting and standing.

Lift	20" (50.8 cm)
Weight Capacity	40 lbs (18.2 kg)
Worksurface Dimensions	32" x 27" (81 x 68.5 cm)
Keyboard Tray Dimensions	28" x 8" (71 x 20 cm)

Part Number / Color / Availability
33-467-921 / Black / Americas, EMEA, AU, NZ



Right-angle power play: WorkFit Corner

Don't cut corners. Use them. The WorkFit Corner Standing Desk Converter turns unused space into a productive right-angle power play. It offers more worksurface and the largest keyboard tray of any WorkFit. The notched worksurface hugs 90-degree cube or office walls to slide into this previous dust collector space.

Lift	15" (38 cm)
Weight Capacity	35 lbs (15.9 kg)
Worksurface Dimensions	36" x 23.6" (91.4 x 60 cm)
Keyboard Tray Dimensions	36" x 13.2" (91 x 33 cm)

Part Number / Color / Availability
33-468-921 / Black / Worldwide (except CN, HK, TW, JP, Southeast Asia)

Tabletop Desk Converters



Large worksurface: WorkFit-TL

WorkFit-TL transforms everyday offices into dynamic, active workspaces. This sit-stand desktop converter offers easy, crank-free height adjustment and holds up to 40 lbs (18.1 kg) of office essentials on a large worksurface. It moves straight up and down for more stability and to keep your space, your space.

Lift	15" (38 cm)
Weight Capacity	10–40 lbs (4.5–18.1 kg)
Worksurface Dimensions	37.5" x 23" (95 x 58.4 cm)
Keyboard Tray Dimensions	27.5" x 11" (69 x 28 cm)

Part Number / Color / Availability
33-406-085 / Black / Worldwide
33-418-085 / Black (TAA Compliant) / USA
33-406-062 / White / Worldwide

WORKFIT TABLETOP DESK CONVERTERS USE AN OUT-OF-THE-BOX DESIGN TO GET YOU STANDING IN MINUTES

WorkFit Monitor Kits



Single LD Monitor Kit



Single HD Monitor Kit



Dual Monitor Kit



LCD & Laptop Kit



Medium worksurface: WorkFit-T

Lift	15" (38 cm)
Weight Capacity	10–35 lbs (4.5–15.9 kg)
Worksurface Dimensions	35" x 23" (88.9 x 58.4 cm)
Keyboard Tray Dimensions	24.7" x 9.2" (62.9 x 23.5 cm)

Part Number / Color / Availability
33-397-085 / Black / Americas, EMEA
33-397-062 / White / Americas, EMEA



Woodgrain finish: WorkFit-Z Mini

Lift	12.5" (31.8 cm)
Weight Capacity	25 lbs (11.3 kg)
Worksurface Dimensions	31" x 15.8" (78.7 x 40.2 cm)
Keyboard Tray Dimensions	24.5" x 9.1" (62 x 23 cm)

Part Number / Color / Availability
33-458-917 / Dove Grey / Worldwide (except AU, NZ)



Front-Mount Desk Converters



Advanced ergonomics: WorkFit-S

The timeless design of the WorkFit-S makes it our best solution for flexible and comfortable working. This height-adjustable standing desk easily attaches to your desktop. Just lift or lower the WorkFit-S with the push and pull of a hand and tweak the optional weight settings for no-sweat adjustment.

Typical LCD Size	Dual ≤ 24" each
Lift	See website
Maximum Weight Capacity	31 lbs (14 kg)

Part Number / Color / Availability
Dual Monitor 33-341-200 / Black / Americas, EMEA



WorkFit-S with Worksurface

This height-adjustable standing desk easily attaches to your desktop and adds a worksurface that stays with you as you sit or stand.

Typical LCD Size	Single LD 27"
Typical LCD Size	Single HD 30"
Typical LCD Size	Dual ≤ 24" each
Lift	See website
Weight Capacity	See website
Worksurface Dimensions	23" x 15" (58.5 x 38 cm)
Keyboard Tray Dimensions	27" x 9" (68.5 x 22.6 cm)

Part Number / Color / Availability
Single LD 33-350-200 / Black / Worldwide
Single HD 33-351-200 / Black / Worldwide
Dual Monitor 33-349-200 / Black / Worldwide
Dual Monitor 33-349-211 / White / Worldwide

WorkFit-S Accessories



**WorkFit Conversion Kit:
Dual to LCD & Laptop**
97-617 Black



**Tablet/Document Holder
(with lift handle)**
97-558-200 Black



Grommet Mount
97-649-085 (EMEA, APAC)



Dual Monitor Double-Hinged Bow
98-101-009 Black



Corner Keyboard Tray
97-898 Black



Small CPU Holder
80-063-200 Black

WorkFit Accessories



Anti-Fatigue Floor Mat
 Neo-Flex Large 98-076
 WorkFit Large 97-620-060
 WorkFit Small 98-080-060

office





office

Rear-Mount Desk Converters



Tall users work happy: WorkFit-SR

Own your space while infusing movement and ergonomics with the WorkFit-SR. Take the worksurface/keyboard tray and monitor pivots to new heights to keep tall users feeling and working happy. Individual monitor and worksurface adjustment personalizes each fit. The integrated tray hugs your desktop when sitting to blend seamlessly with your tabletop.

Typical LCD Size	Dual ≤ 24" each
Lift	See website
Maximum Weight Capacity	≤ 25 lbs (11.3 kg)

Part Number / Color / Availability
 Dual Monitor 33-407-085 / Black / Worldwide
 Dual Monitor 33-407-062 / White / Worldwide

Ultra-movable: WorkFit-A with Worksurface

Swing for the fences with the ultra-movable WorkFit-A. The arm-based design lets you swing your full standing workstation left, right, up or down to sit or stand while you work. One easy movement adjusts the complete workstation through the full 20" (51 cm) lift range.

Typical LCD Size	Single LD ≤ 27"
Typical LCD Size	Dual ≤ 24" each
Lift	20" (51 cm)
Weight Capacity	See website

Part Number / Color / Availability
 Single LD 24-317-026 / Polished Aluminum / Americas, EMEA
 Dual Monitor 24-316-026 / Polished Aluminum / Americas, EMEA

WorkFit-A with Suspended Keyboard

Offers the same features and benefits as the WorkFit-A. The keyboard and mouse sit below the desktop for an ergonomics home run when sitting.

Typical LCD Size	Single LD ≤ 24"
Typical LCD Size	Single HD ≤ 30"
Typical LCD Size	Dual ≤ 24" each
Lift	See website
Weight Capacity	See website

Part Number / Color / Availability
 Single LD 24-390-026 / Polished Aluminum / Americas
 Single HD 24-391-026 / Polished Aluminum / Americas
 Dual Monitor 24-392-026 / Polished Aluminum / Americas



Tall User Kit Accessory:
97-615

Flexible design: WorkFit-LX

With the WorkFit-LX standing workstation, you get to choose exactly where you place both your monitor (even large screens!) and your keyboard as you sit or stand. The modular and flexible design fits any space while upping your ergonomic comfort.

Typical LCD Size	≤ 42"
Lift	20" (51 cm)
Weight Capacity	LCD 7–25 lbs (3.2–11.3 kg)
Weight Capacity	Keyboard ≤ 5 lbs (2.2 kg)

Part Number / Color / Availability
 45-405-026 / Polished Aluminum / Worldwide



Full Desks



Non-motorized movement: WorkFit-D

Lift	20" (51 cm)
Weight Capacity	≤ 65 lbs (29.5 kg)
Worksurface Dimensions	47.6" x 23.5" (121 x 60 cm)

Part Number / Color / Availability
24-271-927 / Walnut & Black / Americas, APAC
24-271-928 / Birch & Black / Americas, APAC



Innovative computer cart: WorkFit-C

Lift	25" (63.5 cm)
Weight Capacity	Single LD ≤ 24.9 lbs (11.3 kg)
Weight Capacity	Single HD ≤ 32.5 lbs (14.7 kg)
Weight Capacity	Dual ≤ 32.5 lbs (14.7 kg)
Worksurface Dimensions	24" x 22.8" (60.6 x 58 cm)

Part Number / Color / Availability
Single LD 24-215-085 / Black & Grey / Worldwide
Single HD 24-216-085 / Black & Grey / Worldwide
Dual Monitor 24-214-085 / Black & Grey / Worldwide



**Move wherever your work takes you:
Ergotron Mobile Desk**

The Ergotron Mobile Desk moves with you throughout the office or school and adapts to how you want to work and where. Easily go from sitting or standing for instant collaboration with peers, and travel from individual workspaces to conference rooms and common areas and back again.

Lift	16" (40.6 cm)
Weight Capacity	≤ 15 lbs (7 kg)
Worksurface Height	29–45" (73.7–114 cm)
Worksurface Dimensions	24" x 22" (61 x 56 cm)
Base Footprint	24" x 22" (61 x 56 cm)

Part Number / Color / Availability
24-811-F13 / Maple & Silver / Americas



Wall Workstation



WorkFit Elevate available with two woodgrain laminate options



Walnut Hills



Mendota Maple



**Elevate your work experience:
WorkFit Elevate™ Wall Desk**

Raise the bar on wellness, productivity and collaboration with the WorkFit Elevate Wall Desk. This modern wall mount reimagines underused spaces as a flexible workstation for individual work or collaboration in office common areas, healthcare clinic spaces and more. The height-adjustable surface easily adjusts from sit to stand, providing the full BIFMA height range of 26" (66 cm) for comfortable working. The flip-down worksurface opens up even more space, and it arrives fully assembled to make install a breeze.

Lift	26" (66 cm)
Weight Capacity	≤ 40 lbs (18.2 kg)
Worksurface Dimensions	Width 28" (71 cm) Height 40.5" (103 cm) Depth 21.5" (55 cm)
Worksurface Dimensions Power Access	Width 28" (71 cm) Height 40.5" (103 cm) Depth 24.5" (62 cm)

Part Number / Color / Availability

24-804-S893 / Snow White & Mendota Maple / Americas, AU, NZ, HK, SG, KO, JP, CN

24-804-S894 / Snow White & Walnut Hills / Americas, AU, NZ, HK, SG, KO, JP, CN

Power Access 24-802-S893 / Snow White & Mendota Maple / Americas

Power Access 24-802-S894 / Snow White & Walnut Hills / Americas

Single Monitor LD Riser Kit 98-448-030 / Snow White / Americas

Single Monitor HD Riser Kit 98-449-030 / Snow White / Americas

Adds more height adjustment for a comfortable fit: Elevate Riser Kit





TRACE™



SHAPE A NEW WORK EXPERIENCE

The innovative TRACE Monitor Mount adapts to the ergonomic needs of each employee to create agile workspaces at home or in the office that effortlessly shift between users and tasks to encourage healthy movement, productivity and a collaborative spirit.



Embrace the Technology of Movement™
to improve workplace comfort, collaboration and productivity.

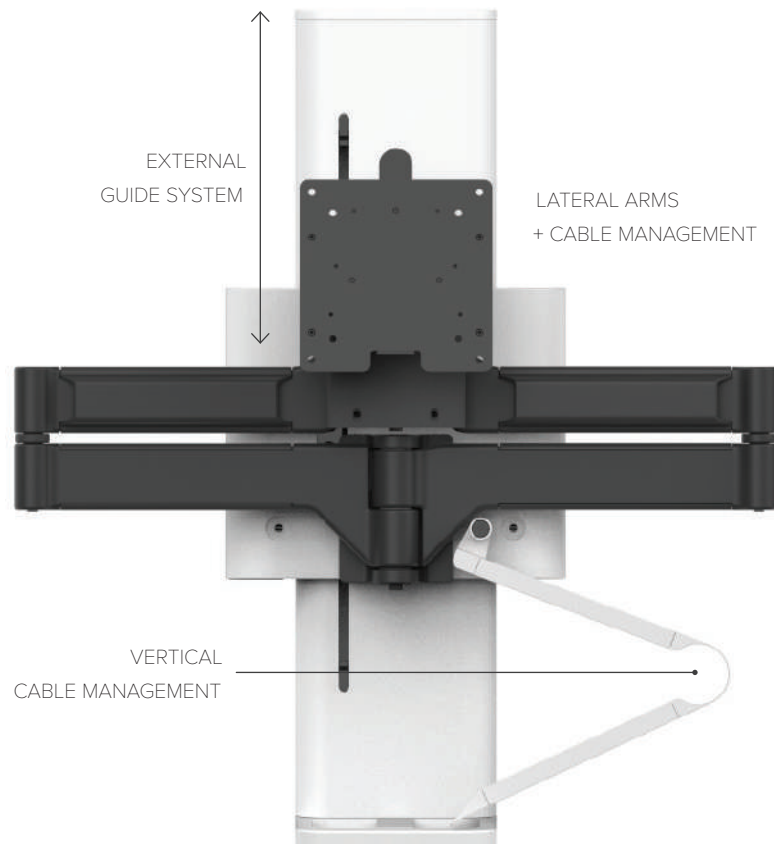

A productive and comfortable workday depends on a personalized set-up that offers employees the freedom to choose how they work best. TRACE embraces movement by tracing the path from individual to collaborative work, always returning to the natural home position.

Intuitive adjustment using patented Constant Force™ Technology positions screens at an ergonomic height for comfortable working in dedicated or shared workspaces. Integrated cable management reduces clutter with a compact base that maintains valuable workspace. The flexible design accommodates future technology changes with a 15-year warranty to get more from your investment.



Embrace your next move:
TRACE Single Monitor Mount
with Panel Clamp

This innovative mount adapts to how each user works and feels their best to create ergonomic, flexible workspaces. It intuitively adjusts between tasks and postures, always returning to the natural home position.

Typical LCD Size	21.5–38"
Lift	11" (28 cm)
Weight Capacity	6.5–21.5 lbs (3–9,8 kg)

Part Number / Color / Availability
45-630-216 / White / Worldwide
45-630-224 / Matte Black / Worldwide



TRACE Dual Monitor Mount
with Panel Clamp

Typical LCD Size	21.5–27"
Lift	11" (28 cm)
Weight Capacity	8.1–21.5 lbs (3.7–9.8 kg)

Part Number / Color / Availability
45-631-216 / White / Worldwide
45-631-224 / Matte Black / Worldwide

Clamp Kits



Slim Profile
98-490-224 (Matte Black)



Slim Profile
98-490-216 (White)



Grommet
98-492-009 (Matte Black)

Conversion Kits

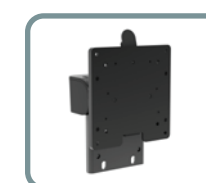

Single
47-109-224 (Matte Black)



Dual
47-110-224 (Matte Black)



MEET OUR MOST POPULAR MONITOR ARMS

Our professional-grade monitor arms add comfort, productivity and space to every work area. Rigorous quality requirements exceed the industry standards for cycle, load and tip testing to create quality, ergonomic solutions for your office that last.



office



CF
Constant Force™

Easy adjustment and long-lasting dependability with innovative coiled-spring technology

DESK MOUNT MONITOR ARMS



Premium, Innovative Design



Work and play reimagined: HX Desk Arm with HD Pivot

Combines our popular HX Desk Monitor Arm with our HX Heavy-Duty Tilt Pivot accessory to give gamers and office professionals an immersive viewing experience on ultra-wide, curved displays.

Typical LCD Size	≤ 49"
Lift	11.5" (29.2 cm)
Weight Capacity	Wide curved displays 6–12" (15.2–30.4 cm) deep and weighing 28–42 lbs (12.7–19.1 kg)

Part Number / Color / Availability
45-647-216 / White / Worldwide
45-647-224 / Matte Black / Worldwide



HX Heavy-Duty Tilt Pivot

Add to HX Desk or Wall Monitor Arms to tilt large monitors +15° / -5 degrees.

Typical LCD Size	32–49"
Tilt	+15° / -5°
Weight Capacity	28–42 lbs (12.7–19.1 kg)

Part Number / Color / Availability
98-540-216 / White / Worldwide



Included:
Standard 2-piece
Desk Clamp



Included:
Grommet Mount



HX Triple Monitor Kit

Upgrade an HX arm to hold three monitors.

Typical LCD Size	≤ 24"
Lift	11.5" (29.2 cm)
Weight Capacity	2–10.2 lbs (1–4.6 kg) per monitor

Part Number / Color / Availability
98-009-026 / Polished Aluminum / Americas, APAC
98-009-216 / White / Worldwide



Adaptable as you: HX Desk Arm

With the HX Desk Monitor Arm, you can reposition large monitors weighing up to 42 pounds while still enhancing your workspace with a sleek design. Add a dual monitor and handle kit or triple monitor bow kit to up your screen count and your productivity. Your monitor stays within your workspace with a rotation stop that limits the range to 180°.

Typical LCD Size	≤ 49"
Lift	11.5" (29.2 cm)
Weight Capacity	20–42 lbs (9–19 kg)

Part Number / Color / Availability
45-475-026 / Polished Aluminum / Americas, APAC
45-475-216 / White / Worldwide
45-475-224 / Matte Black / Worldwide



HX Desk Dual Arm

Typical LCD Size	≤ 32"
Lift	11.5" (29.2 cm)
Weight Capacity	5–17.5 lbs (2.3–8 kg) per monitor

Part Number / Color / Availability
45-476-026 / Polished Aluminum / Americas, APAC
45-476-216 / White / Worldwide
45-476-224 / Matte Black / Worldwide



Extensive Range Of Motion



Easy adjustment: LX Desk Arm, Single

Place your screen where you need it for each project, and then reclaim a space full of opportunities by folding the arm and pushing it aside during a much-needed screen break. Tall pole option provides greater range of vertical positioning.

Typical LCD Size	≤ 34"
Lift	13" (33 cm)
Weight Capacity	7–25 lbs (3.2–11.3 kg)

Part Number / Color / Availability

45-241-026 / Polished Aluminum / Worldwide

45-490-216 / White / Worldwide

45-241-224 / Matte Black / Worldwide

Low-Profile Top Mount C-Clamp 45-626-216 / White / Americas

Low-Profile Top Mount C-Clamp 45-626-224 / Matte Black / Americas

Tall Pole 45-295-026 / Polished Aluminum / Worldwide

Tall Pole 45-537-216 / White / Worldwide



Grommet Mount
Accessory:
See website



Low-Profile Top Mount C-Clamp
Accessory:
See website

Tablet Accessory



Lockable Tablet Mount
45-460-026



Work sitting or standing: LX Sit-Stand Desk Arm, Single

Easily place large monitors, mid-sized TVs and all-in-one computers up to 30 lbs to work sitting or standing. Integrated cable management tucks cords under the arm and out of sight. Keep your technology secure by anchoring the base.

Typical LCD Size	See website
Lift	20" (51 cm)
Weight Capacity	Single 7–25 lbs (3.2–11.3 kg)
Weight Capacity	HD 14–30 lbs (6.3–13.6 kg)

Part Number / Color / Availability

Single 45-360-026 / Polished Aluminum / Worldwide

Single HD 45-384-026 / Polished Aluminum / Worldwide

FIND YOUR BEST VIEW,
SAVE DESK SPACE
AND DISCOVER
YOUR MOST
PRODUCTIVE SELF



LX Multi-Monitor Arm Configurations

Dual Monitors:

LX Dual Side-by-Side & LX Dual Direct

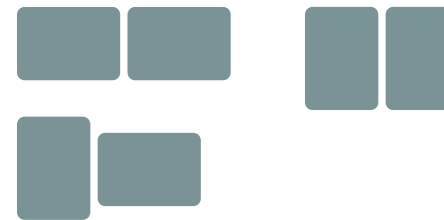

LX Dual Stacking & LX Stacking Tall Pole



LX Dual Stacking Tall Pole



Triple Monitors: LX Dual Stacking Tall Pole + LX Arm, Extension & Collar Kit



Quadruple Monitors: LX Dual Stacking Tall Pole + LX Arm, Extension & Collar Kit

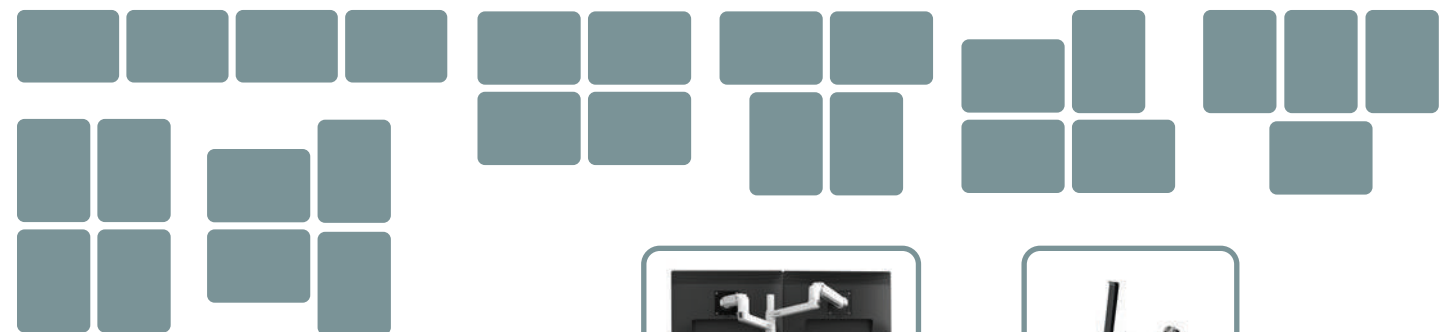

Use an LX Arm to support your laptop with a Notebook Tray Kit 50-193-200



Side-by-Side Or Low Angle Views



Find your best view: LX Dual Side-by-Side Arm

The LX Dual Side-by-Side Arm was designed for side-by-side or low angle screen views. Easily position your dual monitors for the best views, while freeing up your desktop for office essentials. The dual arm extends LCDs or laptops up to 25" (64 cm) with an extension range of 18" (46 cm).

Typical LCD Size	≤ 27"
Lift	13" (33 cm)
Weight Capacity	7–20 lbs (3.2–9.1 kg) per arm

Part Number / Color / Availability
45-245-026 / Polished Aluminum / Worldwide
45-491-216 / White / Worldwide
45-245-224 / Matte Black / Worldwide



Grommet Mount Accessory:
 White LX Dual Side-by-Side Arm 98-035 (grommet mount included with Polished Aluminum arm)

Low-Profile Monitor Crossbar



Lift monitors together: LX Dual Direct Arm

The low-profile monitor crossbar uses a compact range of motion to keep your space, your space. With an individual per monitor weight range of 2–11 lbs (1–5 kg) and a total weight range of 4–22 lbs (1.8–9.9 kg), LX Dual Direct supports a wide variety of monitors. Move two screens even easier with the Dual Direct Handle Kit accessory.

Typical LCD Size	≤ 25"
Lift	13" (33 cm)
Weight Capacity	2–11 lbs (0.9–5.0 kg) per arm

Part Number / Color / Availability
45-489-026 / Polished Aluminum & White / Americas, APAC
45-489-216 / White / Worldwide
45-489-224 / Matte Black / Worldwide
Low-Profile Top Mount C-Clamp 45-627-216 / White / Americas
Low-Profile Top Mount C-Clamp 45-627-224 / Matte Black / Americas



Dual Direct Handle Kit Accessory:
 98-037-062 White
 98-037-224 Matte Black



Grommet Mount Accessory:
 98-034



Low-Profile Top Mount C-Clamp Accessory:
 See website



Stack LCDs Or Position Side-by-Side



Easily rotate one or both screens: LX Dual Stacking Arm

This dual monitor mount lets you position each screen separately for a new level of flexible working. Project wrapped up? Reclaim a space full of opportunities by folding the arms and pushing them aside during a much-needed screen break.

Typical LCD Size	≤ 24"
Lift	13" (33 cm)
Weight Capacity	7–20 lbs (3.2–9.1 kg) per arm

Part Number / Color / Availability
45-248-026 / Polished Aluminum / Worldwide
45-492-216 / White / Worldwide
45-492-224 / Matte Black / Americas, APAC

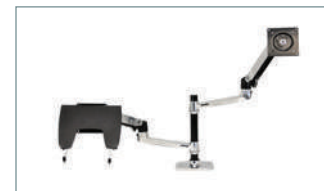

Notebook Tray Kit included with Polished Aluminum LX Dual Stacking Arm; for all other LX Dual Stacking Arms, order kit separately 50-193-200 (Black)



Grommet Mount Accessory:
 98-035
 See all compatible products online

LX Dual Stacking Arm, Tall Pole

Typical LCD Size	≤ 40"
Lift	13" (33 cm)
Weight Capacity	Two arms: 7–20 lbs (3.2–9.1 kg) each
Weight Capacity	Three or four arms: 7–11 lbs (3.2–5 kg) each See website for details

Part Number / Color / Availability
45-549-026 / Polished Aluminum / Worldwide
45-509-216 / White & Grey / Worldwide

Add a third or fourth display: LX Arm, Extension and Collar Kits



45-289-026
 Polished Aluminum
 45-289-216
 White (EMEA only)



97-940-026
 Polished Aluminum
 98-130-216
 White

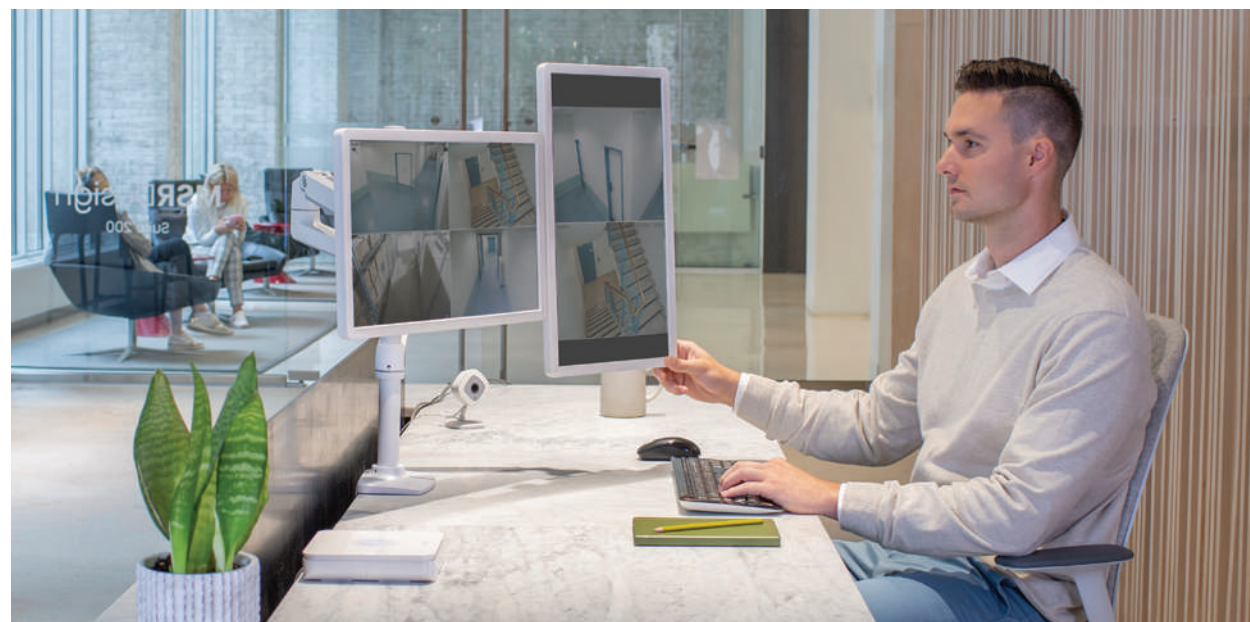

Slim Profile With Rotation Control



Sleek and lightweight: MXV Desk Arm

The sleek and lightweight MXV Desk Monitor Arm incorporates a modern V-shaped design to create a stable yet flexible platform for screens up to 20 lbs (9.1 kg). With a slim profile, MXV offers 13" (33 cm) of height adjustment, up to 19.5" (49 cm) monitor extension, integrated tilt and more—all on a convenient swivel base.

Typical LCD Size	≤ 34"
Lift	13" (33 cm)
Weight Capacity	7–20 lbs (3.2–9.1 kg)

Part Number / Color / Availability
45-486-026 / Polished Aluminum / Americas, APAC
45-486-216 / White / Worldwide
45-486-224 / Matte Black / Americas, APAC
 Low-Profile Top Mount C-Clamp **45-625-216 / White / Americas**
 Low-Profile Top Mount C-Clamp **45-625-224 / Matte Black / Americas**



MXV Desk Dual Arm

Typical LCD Size	≤ 24"
Lift	13" (33 cm)
Weight Capacity	7–20 lbs (3.2–9.1 kg)

Part Number / Color / Availability
45-496-026 / Polished Aluminum / Americas, APAC
45-496-216 / White / Worldwide
45-496-224 / Matte Black / Americas, APAC



Included:
Shallow 2-piece
desk clamp



Grommet Mount
 Accessory:
 Desk Arm 98-110
 Desk Dual Arm 98-111



Low-Profile Top Mount
 C-Clamp Accessory:
 See website



Heavy Monitor Mount



For large monitors: MX Desk Arm

Typical LCD Size	≤ 30"
Lift	5" (13 cm)
Weight Capacity	14–30 lbs (6.4–13.6 kg)

Part Number / Color / Availability
45-214-026 / Polished Aluminum / Worldwide

Neo-Flex Arms



Versatility and value: Neo-Flex Extend LCD Arm

Typical LCD Size	≤ 24"
Weight Capacity	7–20 lbs (3.2–9.1 kg)

Part Number / Color / Availability
45-235-194 / Silver / Worldwide



Affordable ergonomic comfort: Neo-Flex Monitor Arm

Typical LCD Size	≤ 24"
Lift	8" (20 cm)
Weight Capacity	≤ 18 lbs (8.2 kg)

Part Number / Color / Availability
45-174-300 / Silver / Worldwide





Desk Stands



Simultaneously lift and tilt two or three monitors: *LX Lift Stand*

Typical LCD Size	Dual ≤ 24"
Typical LCD Size	Widescreen Dual ≤ 30"
Typical LCD Size	Triple ≤ 21"
Lift	5" (13 cm)
Weight Capacity	Dual 12–34 lbs (5.4–15.4 kg)
Weight Capacity	Widescreen Dual 24–48 lbs (10.9–21.8 kg)
Weight Capacity	Triple 24–48 lbs (10.9–21.8 kg)

Part Number / Color / Availability
Dual 33-299-195 / Black / Americas, EMEA
Widescreen Dual or Triple 33-296-195 / Black / EMEA



Take back your workspace: *DS100 Desk Stands, Dual*

Typical LCD Size	See website
Weight Capacity	Horizontal 31 lbs (14 kg) each
Weight Capacity	Vertical 23 lbs (10.4 kg) each

Part Number / Color / Availability
Horizontal 33-322-200 / Black / Worldwide
Vertical 33-091-200 / Black / Worldwide



Multi-display productivity: *DS100 Desk Stands, Triple & Quad*

Typical LCD Size	Triple Monitor ≤ 21"
Typical LCD Size	Quad Monitor ≤ 24"
Weight Capacity	≤ 31 lbs (14 kg) each

Part Number / Color / Availability
Triple Monitor 33-323-200 / Black / Worldwide
Quad Monitor 33-324-200 / Black / Worldwide



Mount a CPU and monitor: *Neo-Flex All-In-One Lift Stand*

Typical LCD Size	≤ 24"
Lift	5" (13 cm)
Weight Capacity	6–16 lbs (2.7–7.2 kg)

Part Number / Color / Availability
Secure Clamp 33-338-085 / Black / Worldwide
Strap 33-326-085 / Black / Worldwide



Supports two widescreen monitors: *Neo-Flex Dual Monitor Lift Stand*

Typical LCD Size	≤ 24"
Lift	5" (13 cm)
Weight Capacity	14–34 lbs (6.4–15.4 kg)

Part Number / Color / Availability
33-396-085 / Black / Worldwide



Set your screen height for comfortable working: *Neo-Flex Monitor Stand*

Typical LCD Size	≤ 24"
Lift	5" (13 cm)
Weight Capacity	6–16 lbs (2.7–7.2 kg)

Part Number / Color / Availability
33-310-060 / Black & Silver / Worldwide





Lift, turn and tilt: Neo-Flex Notebook Lift Stand

Lift	6" (15.2 cm)
Weight Capacity	3.5–14 lbs (1.6–6.3 kg)

Part Number / Color / Availability
33-334-085 / Black / Worldwide



Tilt your way to the best views:
 Neo-Flex Touchscreen Stand

Typical LCD Size	≤ 27"
Lift	6.5" (16.5 cm)
Weight Capacity	14–23.7 lbs (6.5–10.8 kg)

Part Number / Color / Availability
33-387-085 / Black / Worldwide

Tablet Mounts



Hands-free working: Neo-Flex Desk Tablet Arm

Typical Tablet Size	5.5" x 8" (14 x 20 cm) 8" x 9.75" (20 x 25 cm) max
Weight Capacity	≤ 2.5 lbs (1.1 kg)

Part Number / Color / Availability
45-306-101 / Black / Americas, EMEA



Keep your technology secure:
 Lockable Tablet Mount

Typical Tablet Size	5.3–8.7" (13.5–22 cm) x 7.9–12" (20–30.6 cm)
Typical Screen Size	7.9–13"
Maximum Tablet Depth	0.9" (2.3 cm)
Weight Capacity	≤ 5 lbs (2.3 kg)

Part Number / Color / Availability
45-460-026 / Silver / Worldwide



WALL MOUNT MONITOR ARMS



Premium, Innovative Design



Adaptable as you: HX Wall Arm

With the HX Wall Monitor Arm, you can reposition large monitors weighing up to 42 pounds while still enhancing your workspace with a sleek design. Add a dual monitor and handle kit or triple monitor bow kit to up your screen count and your productivity. Your monitor stays within your workspace with a rotation stop that limits the range to 180°.

Typical LCD Size	≤ 49"
Lift	11.5" (29.2 cm)
Weight Capacity	20–42 lbs (9–19 kg)

Part Number / Color / Availability
45-478-026 / Polished Aluminum / Americas, APAC
45-478-216 / White / Worldwide



HX Wall Dual Arm

Typical LCD Size	≤ 32"
Lift	11.5" (29.2 cm)
Weight Capacity	5–17.5 lbs (2.3–8 kg) per monitor

Part Number / Color / Availability
45-479-026 / Polished Aluminum / Americas, APAC
45-479-216 / White / Worldwide



HX Heavy-Duty Tilt Pivot

Not just for gamers, this tilt pivot upgrades an HX arm, providing stability and flexibility for professionals who prefer large or curved displays at home or in the office.

Typical LCD Size	32–49"
Tilt	+15° / -5°
Weight Capacity	28–42 lbs (12.7–19.1 kg)

Part Number / Color / Availability
98-540-216 / White / Worldwide



HX Triple Monitor Kit

Upgrade an HX arm to hold three monitors.

Typical LCD Size	≤ 24"
Lift	11.5" (29.2 cm)
Weight Capacity	2–10.2 lbs (1–4.6 kg) per monitor

Part Number / Color / Availability
98-009-026 / Polished Aluminum / Americas, APAC
98-009-216 / White / Worldwide



Style Meets Functionality



Unparalleled Range Of Motion



Easy adjustment: LX Wall Arm

Place your screen where you need it for each project, and then reclaim a space full of opportunities by folding the arm and pushing it aside during a much-needed screen break.

Typical LCD Size	≤ 34"
Lift	13" (33 cm)
Weight Capacity	7–25 lbs (3.2–11.3 kg)

Part Number / Color / Availability
45-243-026 / Polished Aluminum / Worldwide
45-243-224 / Matte Black / Americas, APAC



Work sitting or standing: LX Sit-Stand Wall Arm

This versatile arm can be used in a variety of applications: attach a smaller monitor for use within a sit-stand workstation or add a large display up to 25 lbs (11.3 kg) to position digital signage.

Typical LCD Size	Sit-stand ≤ 42"
Typical LCD Size	Sit-stand HD ≤ 46"
Lift	20" (50.8 cm)
Weight Capacity	Sit-stand 7–25 lbs (3.2–11.3 kg)
Weight Capacity	Sit-stand HD 14–30 lbs (6.3–13.6 kg)

Part Number / Color / Availability
Sit-stand 45-353-026 / Polished Aluminum / Worldwide
Sit-stand HD 45-383-026 / Polished Aluminum / Worldwide

Stable and flexible: MXV Wall Arm

The MXV Wall Monitor Arm incorporates a modern V-shaped design to create a stable yet flexible platform for screens up to 20 lbs (9.1 kg). With a slim profile, MXV offers 13" (33 cm) of height adjustment, up to 24.6" (63 cm) monitor extension, integrated tilt and more.

Typical LCD Size	≤ 34"
Lift	13" (33 cm)
Weight Capacity	7–20 lbs (3.2–9.1 kg)

Part Number / Color / Availability
45-505-026 / Polished Aluminum / Americas, APAC
45-505-216 / White / Americas, APAC
45-505-224 / Matte Black / Americas, APAC

Keyboard Arm



Build a complete ergonomic space: LX Wall Keyboard Arm

Type freely on the no-shake, stable platform that easily adjusts to the most comfortable working height. The back-tilt keyboard tray keeps wrists neutral for comfortable typing, while helping prevent common office injuries.

Keyboard Tray Size	17.6" x 9.5" (44.6 x 24 cm)
Lift	13" (33 cm)
Lift	Sit-stand 20" (51 cm)
Weight Capacity	≤ 5 lbs (2.3 kg)

Part Number / Color / Availability
45-246-026 / Polished Aluminum / Worldwide
Sit-stand 45-354-026 / Polished Aluminum / Worldwide

Heavy Monitor Mount



For large monitors: MX Wall Arm

The sleek MX LCD Arm accommodates larger monitors and all-in-one computers weighing up to 30 lbs (13.6 kgs).

Typical LCD Size	≤ 42"
Lift	5" (13 cm)
Weight Capacity	14–30 lbs (6.4–13.6 kg)

Part Number / Color / Availability
45-228-026 / Polished Aluminum / Worldwide

Additional Wall Mounts!



200 Series

Typical LCD Size	Dual ≤ 22" each
Typical LCD Size	Pivot ≤ 27"
Typical LCD Size	Wall Mount ≤ 27"
Weight Capacity	Dual 13 lbs (5.9 kg) each
Weight Capacity	Pivot 25 lbs (11.3 kg)
Weight Capacity	Wall Mount 25 lbs (11.3 kg)

Part Number / Color / Availability
Dual Monitor 45-231-200 / Black / Worldwide
Monitor Pivot 45-232-200 / Black / Worldwide
Wall Mount 1 extension 45-233-200 / Black / Worldwide
Wall Mount 2 extensions 45-234-200 / Black / Worldwide



LX Wall Mount Swing Arm & Pivot

Typical LCD Size	≤ 42"
Weight Capacity	50 lbs (22.7 kg)

Part Number / Color / Availability
HD Swing Arm 45-268-026 / Polished Aluminum / Worldwide
Monitor Pivot 45-269-009 / Polished Aluminum / Worldwide



100 Series

Typical LCD Size	≤ 27"
Weight Capacity	Single ≤ 25 lbs (11.3 kg)
Weight Capacity	Pivot ≤ 23 lbs (10.4 kg)

Part Number / Color / Availability
Single 47-092-800 / Black or Grey / Worldwide
Pivot 47-093-800 / Black or Grey / Worldwide



Tilting & Low Profile Mount

Typical LCD Size	TM Tilting $\geq 32"$
Typical LCD Size	TM XL Tilting $\geq 42"$
Typical LCD Size	WM Low Profile $\geq 32"$
Typical LCD Size	WM XL Low Profile $\geq 42"$
Weight Capacity	≤ 175 lbs (79 kg)

Part Number / Color / Availability
TM Tilting 61-143-003 / Silver / Worldwide
TM XL Tilting 61-142-003 / Silver / Worldwide
WM Low Profile 60-604-003 / Silver / Worldwide
WM XL Low Profile 60-602-003 / Silver / Worldwide



SIM90 Signage Mount

Typical LCD Size	$\geq 32"$
Weight Capacity	≤ 105 lbs (47.6 kg)

Part Number / Color / Availability
60-600-009 / Black / Worldwide



Glide Wall Mount

Typical LCD Size	LD-X 27–42"
Typical LCD Size	HD 30–55"
Typical LCD Size	VHD 46–63"
Lift	LD-X 10" (25.4 cm)
Lift	HD 18" (46 cm)
Lift	VHD 16" (40.6 cm)
Weight Capacity	LD-X 12–30 lbs (5.4–13.6 kg)
Weight Capacity	HD 20–40 lbs (9.1–18.1 kg)
Weight Capacity	VHD 45–70 lbs (20.4–32 kg)

Part Number / Color / Availability
LD-X 61-113-085 / Black / Worldwide
HD 61-061-085 / Black / Americas, APAC
VHD 61-128-085 / Black / Worldwide



FX30 Wall Mount

Typical LCD Size	$\leq 37"$
Weight Capacity	≤ 30 lbs (13.6 kg)

Part Number / Color / Availability
60-239-007 / Black / Worldwide



Interactive Arm

Typical LCD Size	LD $\leq 42"$
Typical LCD Size	HD 30–55"
Typical LCD Size	VHD 40–63"
Lift	20" (51 cm)
Weight Capacity	LD 7–25 lbs (3.2–11.3 kg)
Weight Capacity	HD 18–40 lbs (8.2–18.2 kg)
Weight Capacity	VHD 35–70 lbs (15.9–31.8 kg)

Part Number / Color / Availability
LD 45-361-026 / Polished Aluminum / Worldwide
HD 45-296-026 / Polished Aluminum / Worldwide
VHD 45-304-026 / Polished Aluminum / Worldwide



Neo-Flex Cantilever Mount

Typical LCD Size	VHD $\leq 63"$
Typical LCD Size	UHD $\geq 37"$
Weight Capacity	VHD ≤ 80 lbs (36.3 kg)
Weight Capacity	UHD ≤ 120 lbs (54.4 kg)

Part Number / Color / Availability
VHD 45-385-223 / Black / Worldwide
UHD 61-132-223 / Black / Worldwide



Neo-Flex Wall Mount, ULD

Typical LCD Size	13–32"
Weight Capacity	≤ 40 lbs (18.1 kg)

Part Number / Color / Availability
97-589 / Black / Worldwide



Ceiling Mount



Endless tilt and pitch adjustment: Neo-Flex Projector Ceiling Mount

Weight Capacity	≤ 40 lbs (18.1 kg)
-----------------	-------------------------

Part Number / Color / Availability
60-623 / Black / Worldwide

MOBILE WORKING

Height-adjustable options for any industry



Add movement to any space: Neo-Flex LCD & Laptop Cart

Typical LCD Size	LCD ≤ 22"
Typical LCD Size	Laptop 12–17" laptop
Lift	LCD 27" (68.6 cm)
Lift	Laptop 20" (50.8 cm)
Weight Capacity	LCD ≤ 26 lbs (11.8 kg)
Weight Capacity	Laptop ≤ 15 lbs (6.8 kg)

Part Number / Color / Availability
LCD Cart 24-206-214 / Two-tone Grey / Worldwide
Laptop Cart 24-205-214 / Two-tone Grey / Worldwide

Widen your view: Neo-Flex WideView WorkSpace

Typical LCD Size	Single 42"
Typical LCD Size	Dual ≤ 22"
Lift	20" (51 cm)
Weight Capacity	Single 16–30 lbs (7.3–13.6 kg)
Weight Capacity	Dual 6–14 lbs (2.7–6.4 kg) each

Part Number / Color / Availability
Single Monitor 24-189-055 / Two-tone Grey / Americas, APAC
Dual Monitor 24-194-055 / Two-tone Grey / Worldwide



Digital signage that moves: Neo-Flex Mobile MediaCenter

Typical LCD Size	LD 27–60"
Typical LCD Size	VHD 37–75"
Typical LCD Size	UHD 50–80"
Lift	20" (51 cm)
Weight Capacity	LD 25–50 lbs (11.3–22.7 kg)
Weight Capacity	VHD 50–90 lbs (22.7–40.9 kg)
Weight Capacity	UHD 90–120 lbs (40.9–54.4 kg)

Part Number / Color / Availability
LD 24-190-085 / Black / Worldwide
VHD 24-191-085 / Black / Worldwide
UHD 24-192-085 / Black / Worldwide
 Accessories / Availability
Camera Shelf 97-491-085 / Worldwide
MMC VESA-CPU Mount 97-527-009 / Worldwide

Accessories: Neo-Flex Cart & Workspace



NF Cart Handle & Basket Kit
97-545



NF Cart Wire Basket Kit
97-544



Universal CPU Holder
80-105-064



NF Cart Laptop Vertical Kit
97-546



Caregivers have many distractions that take their focus away from patients—technology should not be one of them. Ergotron products remove constraints from how caregivers work with technology to help reduce burnout and to improve the patient experience. Together, we are moving care forward.

Carts

CONFIGURATIONS TO FIT YOUR WORKFLOWS

Move your care where it's needed most with a mobile workstation.

Wall Mounts

GET MORE FROM YOUR SPACE

Free up room in your facility for personal interaction with patients and families.

Charging Cabinets

POWER UP YOUR TECHNOLOGY

Keep your smart devices secured, protected and charged for easy documentation.

and more!



CAREFITTM SLIM

Ultra-lean Documentation Cart



Short, tall or average clinicians can now work comfortably and effectively—no matter what their stature. Help all of your caregivers thrive with an expansive vertical range that easily adjusts to the ergonomic needs of the broadest range of users. The lightweight design makes it easy to move wherever your work takes you around the healthcare facility.

CareFit Slim 2.0 LCD Medical Carts offer a pull-out keyboard and large worksurface to support large all-in-one computers and monitors, with no-drawer and one-drawer models available.

- 1 Designed for lean IT configurations, including micro PC + LCD or AIO 21–27" weighing up to 20 lbs (9.1 kg)
- 2 Telescopic lift provides an additional 5" (13 cm) of monitor height adjustment
- 3 Spacious worksurface is 20.7" x 14.3" (52.5 x 36.3 cm)
- 4 Slide-out keyboard tray and pull-out mouse tray (left or right side) hides under the keyboard tray when not in use
- 5 Offers easy height adjustability with the pull of a lift handle
- 6 Accessory shelf for printer or scanner on left; sani-wipes holder on right
- 7 Lift engine offers an expansive vertical range of 29.25–46.75" (74–119 cm)
- 8 Easily add a hot-swap power system
- 9 Compact cast aluminum base with durable finish; includes three-function 4" (10.2 cm) casters

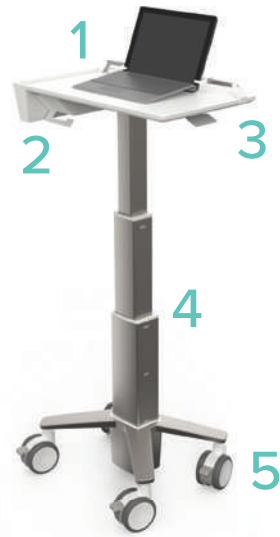

CareFit Slim Laptop Carts fit laptops and two-in-ones. A pull-out cable storage tray keeps cords out of sight, and a slide-out power brick holder offers easy access to power options.

- 1 CareFit Slim Laptop Security Bracket keeps your laptop from sliding, while helping protect important equipment
- 2 Integrated storage area and pull-out cable storage tray with quick connect hardware
- 3 Worksurface is 21" x 13.9" (53.3 x 35.3 cm)
- 4 Triple-stage lift engine offers an expansive vertical range of 24.5–49.1" (61.4–124.7 cm)
- 5 Super-compact cast aluminum base with durable finish; includes three-function 4" (10.2 cm) casters

CareFit Slim 2.0 LCD Cart

Typical LCD Size	Designed for lean IT configurations, including micro PC + LCD or AIO 21–27" weighing up to 20 lbs (9.1 kg)
Lift	17.5" (44.5 cm)
Base Footprint Dimensions	18" x 16.7" (46 x 42 cm)

Part Number / Color / Availability

No Drawer C50-3500-0 / White & Warm Grey / Worldwide
1 Drawer C50-3510-0 / White & Warm Grey / Worldwide

CareFit Slim Laptop Cart

Typical Laptop Screen Size	≤ 17.3"
Lift	24.6" (62.5 cm)
Base Footprint Dimensions	18.9" x 14.7" (48 x 37 cm)

Part Number / Color / Availability

No Drawer C50-1100-0 / White & Warm Grey / Worldwide



CAREFITTM PRO

Full-featured & Customizable Medical Cart



The CareFitTM Pro Medical Cart sets a new standard in resimercial design and supports calming, healing environments for caregivers and patients alike. A flexible open architecture system reliably adapts to future and current workflows with ease. Integrated, cloud-based software simplifies fleet management, helps improve uptime and alleviates power anxiety.

- 1 180° pan for monitor and keyboard
- 2 Touchscreen user interface
- 3 High-capacity configurable drawer system can be added
- 4 Infinite brake mechanism enhances patented Constant ForceTM technology for improved usability; electric lift also available
- 5 Integrated 320Wh LiFe battery
- 6 Durable, 5" (12.7 cm) dual-wheel casters
- 7 Optional LiFeKinnex Power System (245Wh)
- 8 Cantilever monitor mount for focal depth adjustability and full access to worksurface
- 9 LED lighting located on the base, keyboard and worksurface for working in dark environments
- 10 Neutral-angle, dual-grip handle design for improved push/pull/lift ergonomics
- 11 Integrated 7-port USB hub for data and power
- 12 Technology enclosure
- 13 Enclosed cable management
- 14 Flex-platform accessory mounting system
- 15 Promote uptime with eKinnexTM software for proactive fleet management

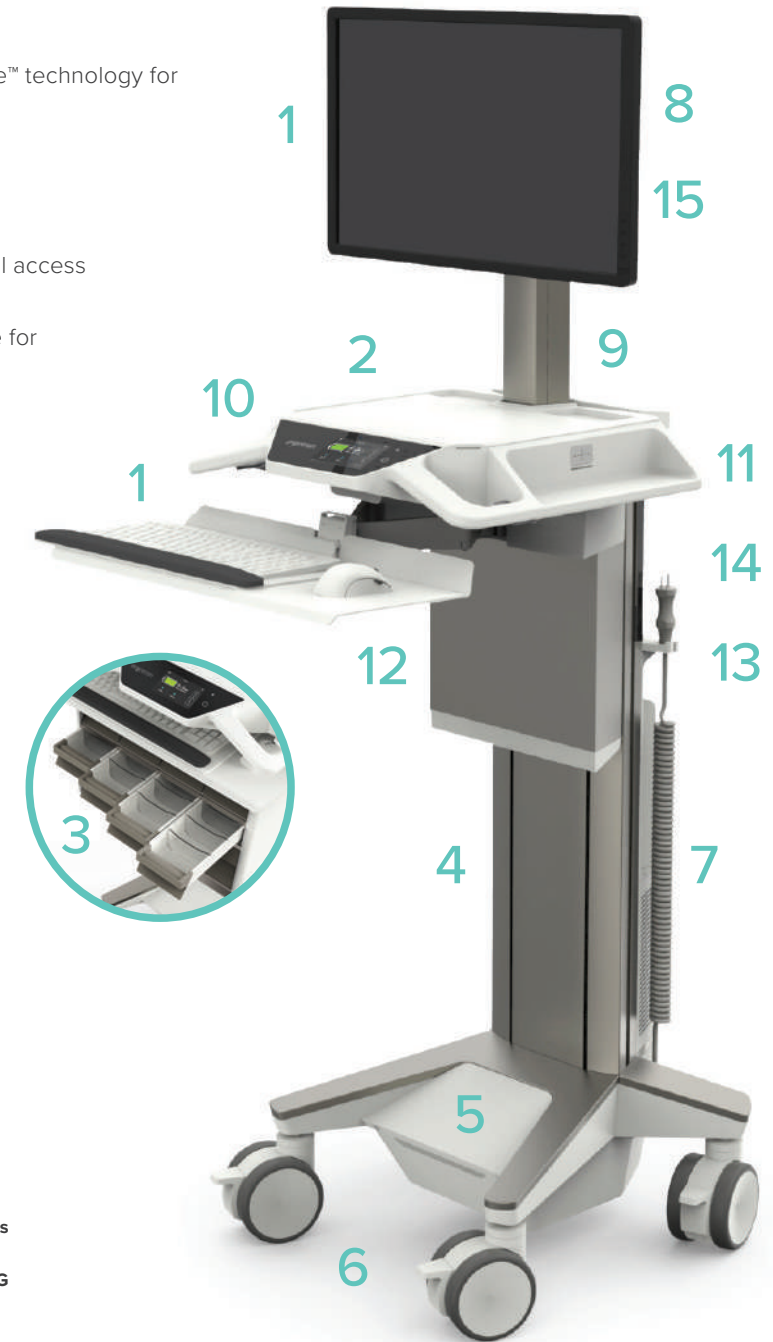

CareFit Pro with multiple drawer configurations!

CareFit Pro Medical Cart

Typical LCD Size	Up to 27" or 20 lbs (9.1 kg)
Lift	27" (68.6 cm): 22" (56 cm) + 5" (12.7 cm) independent monitor lift
Worksurface Dimensions	14" x 16" (35.6 x 40.6 cm), expandable to 14" x 23" (35.6 x 58.4 cm)
Base Footprint Dimensions	20" x 21" (50.8 x 53.3 cm)

Part Number / Color / Availability

Constant Force Lift Technology C52-1201-1 / White & Warm Grey / Americas
Constant Force Lift Technology C52-1201-2 / White & Warm Grey / EU
Constant Force Lift Technology C52-1201-3 / White & Warm Grey / UK, HK, SG
Constant Force Lift Technology C52-1201-4 / White & Warm Grey / AU, NZ
Constant Force Lift Technology C52-1201-5 / White & Warm Grey / CN
Constant Force Lift Technology C52-1201-C / White & Warm Grey / CHE
Electric Lift Technology C52-2201-1 / White & Warm Grey / Americas
Electric Lift Technology C52-2201-2 / White & Warm Grey / EU
Electric Lift Technology C52-2201-3 / White & Warm Grey / UK, HK, SG
Electric Lift Technology C52-2201-4 / White & Warm Grey / AU, NZ
Electric Lift Technology C52-2201-5 / White & Warm Grey / CN
Electric Lift Technology C52-2201-C / White & Warm Grey / CHE

CUSTOMIZABLE FOR EVERY WORKFLOW

Need drawer storage?
If so, how many?

- **One row:**
Select our cart with patented Constant Force Technology.
- **More than one row:**
Select our cart with an electric lift.
Mix and match up to a total of 4 rows (1 Drawer, 1x1) on an electric cart.

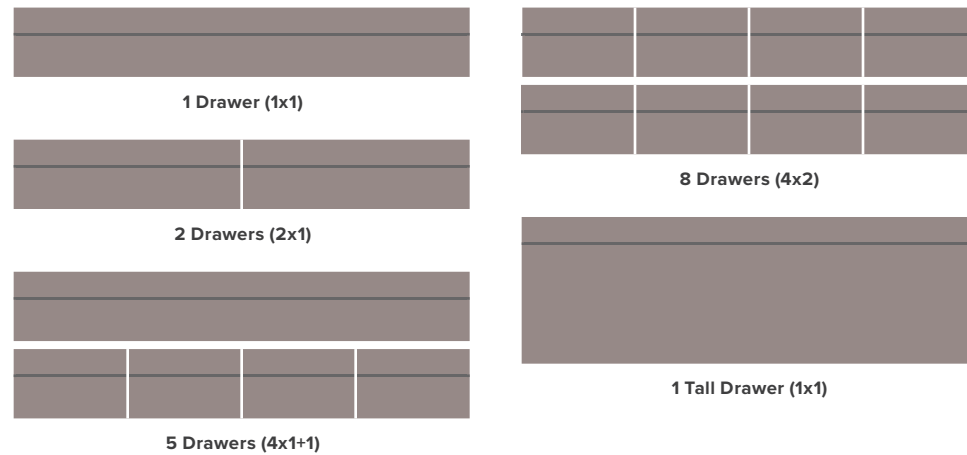







Supports Imprivata identity and access management.

CareFit Pro Medical Cart With Drawers

- Part Number / Availability
- 1 Drawer (1x1)
Constant Force Lift Technology C52-1211-1 / Americas
Constant Force Lift Technology C52-1211-2 / EU
Constant Force Lift Technology C52-1211-3 / UK
Constant Force Lift Technology C52-1211-C / CHE
 - 1 Drawer (1x1)
Electric Lift Technology C52-2211-1 / Americas
Electric Lift Technology C52-2211-2 / EU
Electric Lift Technology C52-2211-3 / UK
Electric Lift Technology C52-2211-C / CHE
 - 2 Drawers (2x1)
Electric Lift Technology C52-22A1-1 / Americas
Electric Lift Technology C52-22A1-2 / EU
Electric Lift Technology C52-22A1-3 / UK
Electric Lift Technology C52-22A1-C / CHE
 - 5 Drawers (4x1+1)
Electric Lift Technology C52-2251-1 / Americas
Electric Lift Technology C52-2251-2 / EU
Electric Lift Technology C52-2251-3 / UK
Electric Lift Technology C52-2251-C / CHE
 - 8 Drawers (4x2)
Electric Lift Technology C52-2281-1 / Americas
Electric Lift Technology C52-2281-2 / EU
Electric Lift Technology C52-2281-3 / UK
Electric Lift Technology C52-2281-C / CHE
 - 1 Tall Drawer (1x1)
Electric Lift Technology C52-22B1-1 / Americas
Electric Lift Technology C52-22B1-2 / EU
Electric Lift Technology C52-22B1-3 / UK
Electric Lift Technology C52-22B1-C / CHE
- Accessories
- Quad Drawer 98-485 / Worldwide
 - Double Drawer 98-486 / Worldwide
 - Single Drawer 98-487 / Worldwide
 - Double Tall Drawer 98-488 / Worldwide
 - Single Tall Drawer 98-489 / Worldwide

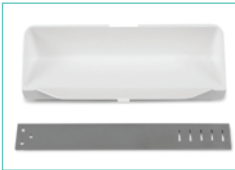

Build Your CareFit Pro Cart: Accessories To Enhance Your Workflow

 Direct Install T-Nut Kit 98-432	 Supply Tray 98-439
 Bin 98-438	 Wipes Holder 98-435
 Slotted Shelf 98-436	 Worksurface Expansion Kit 98-437
 Document Holder Replacement for standard cart feature 98-433	 Rear Document Holder Replacement for standard cart feature 98-434



TAILORED HEALTHCARE SOLUTIONS

Every care setting requires professional-grade products tailored for your workflows. Combining several of our products into specialized, expert solutions delivers what you need in each application for patient-centered care.

Timesaving And Comfortable Patient Registration



Tailored Solutions—Registration Carts

Powered mobile medical carts with thoughtful features and accessories make registration efficient and patient-centered.

Hot Swap power configuration

SV41-63000-0	StyleView Cart with LCD Pivot
97-507-216	Utility Shelf
97-780-194	SV Scanner Shelf
97-650	Pan Pivot Kit for SV LCD Cart
97-754-002	SV Tasklight
97-863	Primary Storage Drawer, Single
98-258	LiFeKinnex 4-Bay Charger
98-246	LiFeKinnex Battery
98-247	LiFeKinnex Smart Battery Dock

Thoughtful Designs For Smooth Workflows



Tailored Solutions—Phlebotomy Carts

Support speedy and comfortable blood draws with a height-adjustable, mobile design that keeps supplies at the ready.

Non-powered laptop configuration

SV43-11B0-0	StyleView Laptop Cart, 1 Tall Drawer (1x1)
97-780-194	SV Scanner Shelf
97-754-002	SV Tasklight
98-134	SV Front Tray
98-136-216	SV Wire Basket, Small
97-974	SV43/44 Supplemental Single Tall Drawer
97-466-214	Medical-Grade Power Strip

Ergotron's StyleView Medical Carts and wall-mount workstations support care everywhere by using movement to enhance critical workflows and satisfaction for both caregivers and patients. Our customizable products are designed to create positive patient experiences and help exceed patient engagement objectives.

Through ergonomic designs and intuitive features, StyleView workstations adapt to the needs throughout a caregiver's shift, while responding to the unexpected.

Light-duty Documentation Carts



StyleView
S-Tablet Cart, SV10
for Microsoft Surface
SV10-1800-0



StyleView
Tablet Cart, SV10
SV10-1400-0



StyleView
Laptop Cart, SV10
SV10-1100-0



StyleView
Pole Cart
24-818-211



Point-of-care Documentation Carts

Choose monitor mount:

- LCD arm
- LCD pivot
- Laptop

Choose non-powered or powered:

- Lithium Iron
- Phosphate (LiFe)
- Sealed lead acid

Choose accessories:

- Drawers
 - Additional storage
- See pages 52–53

Add a certified service program



StyleView
40 and 41 Series
Laptop version shown
Non-powered



StyleView 42 Series
LCD pivot version shown
Powered with
SLA or LiFe battery



StyleView 42
with Electric Lift
LCD arm version shown
Powered with LiFe battery
(Americas only)



Part numbers vary by country and power requirements.
Use our helpful finder tool at styleview.ergotron.com/finder



Point-of-care Medication Delivery Carts & Telemedicine Carts

Choose monitor mount:

- LCD arm
- LCD pivot
- Laptop

Choose non-powered or powered:

- Lithium Iron
- Phosphate (LiFe)
- Sealed lead acid

Choose drawer configuration

Choose accessories:
Additional storage
See page 52

Add a certified service program



StyleView 43 Series
LCD arm version shown
Non-powered
Pre-configured with drawers



StyleView 44 Series
LCD pivot version shown
Powered with
SLA or LiFe battery
Pre-configured with drawers



StyleView Telemedicine
Dual monitor version shown
Powered with SLA battery
Pre-configured with
connectivity and storage for
telemedicine applications

Part numbers vary by country and power requirements.
Use our helpful finder tool at styleview.ergotron.com/finder

StyleView Carts

Typical LCD Size	LCD Arm ≤ 24"
Typical LCD Size	LCD Pivot ≤ 24"
Typical LCD Size	Laptop ≤ 17"
Lift	LCD Arm 27" (68.6 cm)
Lift	LCD Pivot 25" (63.5 cm)
Lift	Laptop 20" (51 cm)
Worksurface Dimensions	22.4" x 19.75" (56.7 x 50.2 cm)
Base Footprint Dimensions	17" x 21" (43 x 53.3 cm)

Part Number / Color / Availability
See website

	Certification Standard	Certification Mark	Grounded Plug & Outlet
U.S.A.	UL 60601-1	cTUVus	North American NEMA 5-15P Hospital Grade
Canada	CAN/CSA C22.2 No. 601.1 M90	cTUVus	North American NEMA 5-15P Hospital Grade
Mexico	As Needed	As Needed	North American NEMA 5-15P Hospital Grade
Europe	EN 60601-1	CE	European CEE 7
Ireland/ United Kingdom	EN 60601-1	CE	United Kingdom BS 1363
Hong Kong/ Malaysia/ Singapore	IEC 60601-1	Not Applicable	United Kingdom BS 1363
China	IEC 60601-1	Not Applicable	GB2009-1 GB1002-1
Australia/ New Zealand	IEC 60601-1	C-Tick	Australian AS NZS 3112
Saudi Arabia (EMR SLA)	EN 60601-1	Not Applicable	United Kingdom BS 1363 European CEE 7

Build Your Styleview Cart: Accessories To Enhance Your Workflow



SV Front Shelf
98-417-214 (Americas)



Sharps Container T-Slot Bracket Kit*
97-959 (Americas)



Security Bracket and Lock Kit*
98-373 (Americas)



LiFeKinnex Side-Mount Bracket Kit
98-370 (Americas)

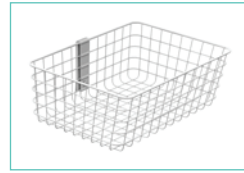

SV Wire Basket
Small 98-136-216 / Large 98-135-216



SV Tasklight
97-754-002



SV43/44 Envelope Drawer
97-853



SV Storage Bin
97-740



SV Dual Monitor Kit*
98-030



Utility Shelf
97-507-216



SV Scanner Shelf*
97-780-194



SV Front Tray
98-134



SV Camera Shelf*
97-776-194



T-Slot Wipes Holder
98-450



Mini PC Mount*
80-107-200



Universal CPU Holder*
80-105-064



SV IV Pole Clamp Kit
97-632



SV 3-Function Caster
98-069



SV Telemedicine Bin*
97-854



Scanner Holder
97-543-207



SV Rear VESA Mount Kit
97-512-009



Large Utility Shelf
97-540-053



K-Slot Lock Kit
97-702



Pan Pivot Kit
97-650



Sharps Container Drawer-Mount Bracket Kit*
98-414-251 (Americas)

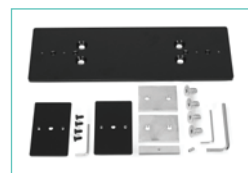

LiFeKinnex Track-Mount Kit, for GCX
98-410 (Americas)



SV Height-Adjustable Keyboard Arm for SV LCD Carts
97-827



SV Ethernet Side Cover
LCD 97-855
Laptop 97-856

*Displays, cameras and components shown are sold separately.



Build Your Styleview Cart: Numerous Drawer Configurations

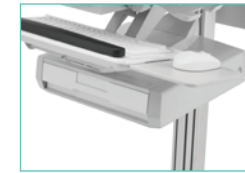

1 Drawer
1 primary, single



2 Drawers
1 primary, single
1 supplemental, single



4 Drawers
1 primary, triple
1 supplemental, single

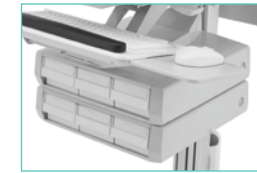

6 Drawers
1 primary, triple
1 supplemental, triple



9 Drawers
1 primary, triple
2 supplemental, triple



3 Drawers
1 primary, single
2 supplemental, single

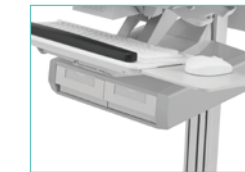

2 Drawers
1 primary, double

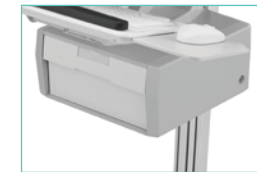

1 Tall Drawer
1 primary, single tall



2 Tall Drawers
1 primary, double tall



15 Drawers
1 primary, triple
4 supplemental, triple

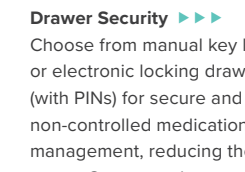

Drawer Security ▶▶▶
Choose from manual key lock drawers or electronic locking drawer systems (with PINs) for secure and efficient non-controlled medication management, reducing the chance for errors. Supports pharmacy mode, allowing all drawers to be unlocked simultaneously.



Charging Cabinet



Slim storage for up to 12 tablets and Chromebooks: Zip12

Part Number / Color / Availability
DM12-1006 / Black & Silver / Worldwide except Japan



Automated Pathogen Reduction



UV Angel® for StyleView

Help control the spread of COVID-19 and other infections with UV Angel Adapt™ technology for StyleView Medical Cart worksurfaces and keyboards.

Part Number / Availability
Keyboard Kit 98-525-085 / North America
Worksurface Kit 98-526-086 / North America
Analytics Software 88-004 / North America (1-Year Subscription)





LK
LiFeKinnex™

POWER LIFE-CHANGING CARE

- Safe battery chemistry
- Longer battery cycle life
- Quick charging time
- Easy to connect
- Simple attachment system

Alleviate power anxiety on medical carts with this innovative battery system designed to support multiple workflows, including hot swap or on-cart charging. The three-part system—battery, smart battery dock and optional external four-bay charger—minimizes downtime by monitoring battery run-time with an LCD screen and using the unique magnetic connection feature for an easy swapping process.

Power Output	AC
Battery Type	Lithium-Iron Phosphate (LiFe)
Battery Capacity	245Wh
Charge Time	1.75 hours
Run Time	5–8 hours (typical load)
Battery Weight	6.7 lbs (3 kg)

Part Number / Availability
LiFeKinnex Battery 98-246 / Worldwide
 Battery not included with Smart Battery Dock & 4-Bay Charger
LiFeKinnex Smart Battery Dock 98-247 / Americas
LiFeKinnex Smart Battery Dock 98-250 / EU
LiFeKinnex Smart Battery Dock 98-251 / UK, SG, MY, HK
LiFeKinnex Smart Battery Dock 98-252 / CHE
LiFeKinnex Smart Battery Dock 98-253 / AU, NZ
LiFeKinnex Smart Battery Dock 98-255 / JP
Optional LiFeKinnex 4-Bay Charger 98-258 / Americas
Optional LiFeKinnex 4-Bay Charger 98-260 / EU
Optional LiFeKinnex 4-Bay Charger 98-261 / UK, SG, MY, HK
Optional LiFeKinnex 4-Bay Charger 98-262 / CHE
Optional LiFeKinnex 4-Bay Charger 98-263 / AU, NZ
Optional LiFeKinnex 4-Bay Charger 98-265 / JP
Certification
 UN/DOT 38.3, IEC 62133, WEEE, Conflict Minerals Act, REACH, RoHS



ek
eKinnex™

CLOUD-BASED FLEET MANAGEMENT FOR MEDICAL CARTS

- Secure, web-based software application that monitors and manages your fleet of CareFit and StyleView carts
- Seamless and centralized fleet management provides comprehensive cart data to significantly reduce or eliminate cart downtime
- Monitoring helps improve battery life expectancy
- Provides real-time insight into usage patterns, drawer access, battery charge/life and more
- Software operates separately from patient records to reduce concerns with HIPPA compliance
- Easy to get, fast to implement



LiFeKinnex 4-Bay Charger (Desktop)

CAREFIT™ *Low Profile Wall Enclosure*



Space is in high-demand in healthcare environments. With the CareFit Enclosure, you have more room to provide the best patient care. The wall-mount workstation lets caregivers work comfortably sitting or standing in crowded patient rooms or hallways.

- The low-profile design stays close to the wall and folds when not in use to open up more space
- Lock code with up to 10 digits keeps patient data and technology secure
- Interchangeable laminate options let you customize the look to design stylish, healing spaces for your organization



Enclosure available in black or white with six woodgrain laminate options



StyleView Enclosure



StyleView VL Enclosure

Typical LCD Size	≤ 22" See website
Lift	9" (23 cm)
Weight Capacity	See website

Part Number / Color / Availability
60-595-062 / White / Worldwide



CareFit Enclosure

Typical LCD Size	24" See website
Lift	20" (51 cm)
Weight Capacity	≤ 23.5 lbs (10.7 kg)

Part Number / Color / Availability
61-367-060 / Matte Black / Worldwide
61-367-030 / Snow White / Worldwide
 Accessory / Part Number / Color / Availability
 Laminate 98-419-891 / Walnut Heights / Americas, APAC
 Laminate 98-419-888 / Fonhill Pear / Americas, APAC
 Laminate 98-419-890 / Phantom Ecrú / Americas, APAC
 Laminate 98-419-889 / Phantom Cocoa / Americas, APAC
 Laminate 98-419-887 / Wild Cherry / Americas, APAC
 Laminate 98-419-906 / Manitoba Maple / Americas, APAC
 Vertical Scanner Bracket 98-425-060 / Matte Black / Worldwide
 Vertical Scanner Bracket 98-425-030 / Snow White / Worldwide
 Horizontal Scanner Bracket 98-424-060 / Matte Black / Worldwide
 Horizontal Scanner Bracket 98-424-030 / Snow White / Worldwide





Neo-Flex Wall Mount Lift

Typical LCD Size	≤ 27"
Lift	5" (12.7 cm)
Weight Capacity	6–16 lbs (2.7–7.2 kg)

Part Number / Color / Availability
60-577-195 / Black / Worldwide



LX Sit-Stand Wall Mount System

Typical LCD Size	≤ 42"
Lift	20" (51 cm)
Weight Capacity	≤ 7–25 lbs (3.2–11.3 kg)

Part Number / Color / Availability
Medium CPU Holder 45-358-026 / Polished Aluminum / Worldwide
Small CPU Holder 45-359-026 / Polished Aluminum / Worldwide



LX Wall Mount System

Typical LCD Size	≤ 32"
Lift	13" (33 cm)
Weight Capacity	Medium CPU Holder 5–25 lbs (2.3–11.3 kg)
Weight Capacity	Small CPU Holder 7–25 lbs (3.2–11.3 kg)

Part Number / Color / Availability
Medium CPU Holder 45-247-026 / Polished Aluminum / Worldwide
Small CPU Holder 45-253-026 / Polished Aluminum / Worldwide
45-551-216 / White / Worldwide
 White CPU Holder Ordered Separately
Mini PC Mount 80-107-216 / White / Worldwide
Small CPU Holder 80-063-216 / White / Worldwide
Vertical Universal CPU Holder 97-468-216 / White / Worldwide



StyleView Combo System
with Worksurface

Typical LCD Size	≤ 24"
Lift	25" (64 cm) maximum
Weight Capacity	See website

Part Number / Color / Availability
Pan & Small CPU Holder & Wall Track
45-594-026 / Polished Aluminum & Black / Worldwide
Pan & Small CPU Holder & Wall Track
45-594-216 / White / Worldwide
Pan & Medium CPU Holder & Wall Track
45-595-026 / Polished Aluminum & Black / Worldwide
Pan & Medium CPU Holder & Wall Track
45-595-216 / White / Worldwide
Medium CPU Holder & Wall Track
45-270-026 / Polished Aluminum & Black / Worldwide
Small CPU Holder & Wall Track
45-272-026 / Polished Aluminum & Black / Worldwide
Medium CPU Holder & Wall Track 45-270-216 / White / Worldwide
Small CPU Holder & Wall Track 45-272-216 / White / Worldwide



StyleView Combo System

Typical LCD Size	≤ 24"
Lift	25" (64 cm) maximum
Weight Capacity	See website

Part Number / Color / Availability
Medium CPU Holder & Wall Track
45-271-026 / Polished Aluminum & Black / Worldwide
Small CPU Holder & Wall Track
45-273-026 / Polished Aluminum & Black / Worldwide
Medium CPU Holder & Wall Track 45-271-216 / White / Worldwide
Small CPU Holder & Wall Track 45-273-216 / White / Worldwide



LX, Neo-Flex & 200 Series
Wall Mounts

Neo-Flex Dual Monitor Wall Mount
& Keyboard Wall Mount

Typical LCD Size	≤ 24"
Weight Capacity	≤ 50 lbs (22.7 kg) 25 lbs (11.3 kg) per pivot Keyboard 5 lbs (2.3 kg)

Part Number / Color / Availability
Monitor Mount 28-514-800 / Grey & Black / Worldwide
Keyboard Mount 45-403-062 / Grey / Worldwide



200 Series Combo Arm

Typical LCD Size	≤ 24"
Lift	5" (13 cm)
Weight Capacity	LCD 6–18 lbs (2.7–8.2 kg); keyboard, mouse & barcode scanner 5 lbs (2.3 kg)

Part Number / Color / Availability
45-230-216 / White / Worldwide
45-230-200 / Black / Worldwide

StyleView Wall Mounts



StyleView Combo Arm
with Worksurface

Typical LCD Size	≤ 24"
Lift	25" (64 cm) maximum
Weight Capacity	See website

Part Number / Color / Availability
 (Wall Track not included)
Pan 45-583-026 / Polished Aluminum & Black / Worldwide
Pan 45-583-216 / White / Worldwide
45-260-026 / Polished Aluminum & Black / Worldwide
45-260-216 / White / Worldwide



StyleView Combo Arm

Typical LCD Size	≤ 24"
Lift	25" (64 cm) maximum
Weight Capacity	See website

Part Number / Color / Availability
 (Wall Track not included)
45-266-026 / Polished Aluminum & Black / Worldwide
45-266-216 / White / Worldwide



StyleView Vertical Lifts



StyleView Sit-Stand Vertical Lift

Typical LCD Size	≤ 24"
Lift	18" (45.7 cm)
Weight Capacity	Patient Room 8–33 lbs (3.6–15 kg)
Weight Capacity	High Traffic Area 5–30 lbs (2.3–13.6 kg)

Part Number / Color / Availability
Patient Room 61-080-062 / White / Worldwide
Patient Room 61-080-085 / Black / Worldwide
High Traffic Area 61-081-062 / White / Worldwide
High Traffic Area 61-081-085 / Black / Worldwide



StyleView Vertical Lift

Typical LCD Size	≤ 24"
Lift	9" (22.9 cm)
Weight Capacity	Patient Room 8–33 lbs (3.6–15 kg)
Weight Capacity	High Traffic Area 5–30 lbs (2.3–13.6 kg)

Part Number / Color / Availability
Patient Room 60-609-216 / White / Worldwide
Patient Room 60-609-195 / Black / Worldwide
High Traffic Area 60-593-216 / White / Americas, APAC
High Traffic Area 60-593-195 / Black / Worldwide

Add-on Power For Non-Power Carts



SV DC Power System

Power Output	DC
Battery Type	Lithium-Ion
Battery Capacity	330Wh
Charge Time	6–7 hours
Run Time	Up to 15 hours

Part Number / Availability
Laptop version 97-943 / Worldwide
LCD + CPU version 97-942 / Worldwide
Remote User Interface 97-953 / Worldwide
 (Country-specific power cords sold separately)
 Certification
Battery pack: UL 60601-1 / Li Ion Cell: IEC 62133



- Durable**
- Flexible**
- Efficient**
- Innovative**

Harness the limitless potential of interactive, digital learning. Ergotron's professional-grade ChargeFit charging systems fit your changing technology, education spaces and ever-changing school days.

No two days are the same, so the flexible designs evolve with your lesson plans. As movement innovators, we've designed our ChargeFit systems to work with a variety of accessories and environments for you to decide where and how you want to ChargeFit.

CHARGEFIT™



charging carts





Featured		High-capacity	
YES36 Adjusta™	YES Basic	YES40	ZIP40 Charge
Makerspace	Budget friendly	Small footprint	Full size
 TOP SELLER			
Compact YES24 Adjusta also available 			ZIP40 Charge & Manage also available 
Tablets, Chromebooks, iPads, laptops	Tablets, Chromebooks, iPads, laptops	Tablets, Chromebooks, iPads, laptops	Tablets, Chromebooks, iPads, laptops



Move easily from room to room with premium casters

Limited lifetime for the frame; 5 years for other mechanical components; 3 years for electrical components; 1 year for cables

charging cabinets

Wall	Wall	Desktop
YES20	ZIP12	ZIP12
Cabinet	Compact wall cabinet	Compact desk cabinet
		
		
Tablets, smart phones, iPads	Tablets, smart phones, Chromebooks, iPads	Tablets, smart phones, Chromebooks, iPads



Charging cabinets save valuable education space

Limited lifetime for the frame; 5 years for other mechanical components; 3 years for electrical components; 1 year for cables



Patented PowerShuttle technology:

Supports safe and fast charging for tablets and laptops

Continuous monitoring keeps circuit limits in check

In-rush protection helps avoid power spikes

Measured processing manages the current to devices

In a test, our charging cart with PowerShuttle Technology charged up to 40% faster than our competitor's round robin charging cart

CHARGEFIT

Our professional-grade ChargeFit designs combine durable construction with extensive testing to help keep students, staff and devices safe.



Inspire tomorrow's engineers and inventors with the versatile Adjusta Cart. This innovative cart works with a makerspace kit, MXV monitor arm, whiteboard or pegboard shelf accessories for STEM lesson plans. It also serves as a teacher desk, podium, charging cart, storage and hub for TVs and interactive displays.

LEARNFIT™

Our LearnFit family of height-adjustable, mobile desks allows students, teachers and colleagues to break free from constraints that hinder creativity and success, so they can thrive as they learn and work. These kinetic environments drive collaboration across the entire school to support 21st century learning.

From supporting greater focus to building flexible classroom spaces to contributing to positive academic performance, LearnFit creates personalized learning experiences that set the foundation for a lifetime of well-being.



LearnFit Sit-Stand Desk

Transform classrooms, conference rooms or common areas into active spaces with flexible seating using the LearnFit mobile desk.

Lift	16" (40.6 cm)
Weight Capacity	≤ 15 lbs (7 kg)
Worksurface Height	Tall 33.25–49.25" (84–125 cm)
Worksurface Height	Short 29–45" (73.7–114 cm)
Worksurface Dimensions	24" x 22" (61 x 56 cm)
Base Footprint	24" x 22" (61 x 56 cm)

Part Number / Color / Availability

Sit-Stand Desk, Tall 24-481-003 / Grey & Silver / Worldwide

Sit-Stand Desk, Short 24-547-003 / Grey & Silver / Worldwide

Sit-Stand Desk, Short 24-811-F13 / Maple & Silver / Americas



Take your teaching on the move: TeachWell™ Mobile Digital Workspace

Break away from your desk or podium with the TeachWell Mobile Digital Workspace. This compact hub stores all your technology on a height-adjustable platform that lets you choose how you instruct today's learners. Move from desk to desk or quiet corners to drive engagement and collaboration.

Lift	20" (51 cm)
Weight Capacity	See website
Worksurface Height	Minimum 31.8" (81 cm)
Worksurface Height	Maximum 51.8" (132 cm)
Worksurface Dimensions	31" x 21" (79 x 53 cm)
Base Footprint	28.9" x 21" (73 x 53 cm)

Part Number / Color / Availability

24-220-055 / Graphite Grey / Worldwide



We Don't Just Stand Behind Our Products. We Stand Behind You.

Ergotron's high-quality products are backed by specially trained support professionals and optional extended service programs that protect your business investment and enhance ongoing product performance for years to come.

AVAILABLE SERVICES:

- Installation and integration
- Next business day on-site service
- Preventive maintenance
- Extended warranties
- In-warranty and post-warranty repairs
- In-depth on-site product training
- Equipment audit and health check



Certified Service



ergotron®
moving you forward



Download additional resources at ergotron.com

USA & Canada Sales & Corporate Headquarters:

St. Paul, MN USA / 800.888.8458 / +1.651.681.7600 / insidesales@ergotron.com

EMEA Sales:

Amersfoort, The Netherlands / +31.33.45.45.600 / info.eu@ergotron.com

APAC Sales:

Sydney, Australia / apaccustomerservice@ergotron.com

LATAM Sales:

Mexico / +1.800.681.1820 / info.latam@ergotron.com

Worldwide Custom Sales:

custom@ergotron.com

© Ergotron, Inc. revision 11.09.2021 / print 12.08.2020

Literature made in the U.S.A. Content subject to change.

Ergotron devices are not intended to cure, treat, mitigate or prevent any disease.

Patent information available at www.ergotron.com/patents

TRACE, WorkFit, StyleView, LearnFit, Neo-Flex, PowerShuttle, LiFeKinnex, CareFit and eKinnex are trademarks of Ergotron.

870-01-021-EA